

CONDENSING UNIT HEAT PUMP INSTALLATION & SERVICE REFERENCE

© 2020-2023

Daikin Comfort Technologies Manufacturing, L.P.

19001 Kermier Rd., Waller, TX 77484

www.goodmanmfg.com -or- www.amana-hac.com

P/N: IOG-40090

Date: June 2023

IMPORTANT SAFETY INSTRUCTIONS

The following symbols and labels are used throughout this manual to indicate immediate or potential safety hazards. It is the owner's and installer's responsibility to read and comply with all safety information and instructions accompanying these symbols. Failure to heed safety information increases the risk of personal injury, property damage, and/or product damage.



WARNING

High Voltage!

DISCONNECT ALL POWER BEFORE SERVICING OR INSTALLING THIS UNIT. MULTIPLE POWER SOURCES MAY BE PRESENT. FAILURE TO DO SO MAY CAUSE PROPERTY DAMAGE, PERSONAL INJURY OR DEATH.



WARNING

ONLY PERSONNEL THAT HAVE BEEN TRAINED TO INSTALL, ADJUST, SERVICE, MAINTENANCE OR REPAIR (HEREINAFTER, "SERVICE") THE EQUIPMENT SPECIFIED THIS MANUAL SHOULD SERVICE THE EQUIPMENT.

THIS EQUIPMENT IS NOT INTENDED FOR USE BY PERSONS (INCLUDING CHILDREN) WITH REDUCED PHYSICAL, SENSORY OR MENTAL CAPACITIES, OR LACK OF EXPERIENCE AND KNOWLEDGE, UNLESS THEY HAVE BEEN GIVEN SUPERVISION OR INSTRUCTION CONCERNING USE OF THE APPLIANCE BY A PERSON RESPONSIBLE FOR THEIR SAFETY.

CHILDREN SHOULD BE SUPERVISED TO ENSURE THAT THEY DO NOT PLAY WITH THE EQUIPMENT.

THE MANUFACTURER WILL NOT BE RESPONSIBLE FOR ANY INJURY OR PROPERTY DAMAGE ARISING FROM IMPROPER SUPERVISION, SERVICE OR SERVICE PROCEDURES. IF YOU SERVICE THIS UNIT, YOU ASSUME RESPONSIBILITY FOR ANY INJURY OR PROPERTY DAMAGE WHICH MAY RESULT. IN ADDITION, IN JURISDICTIONS THAT REQUIRE ONE OR MORE LICENSES TO SERVICE THE EQUIPMENT SPECIFIED IN THIS MANUAL, ONLY LICENSED PERSONNEL SHOULD SERVICE THE EQUIPMENT. IMPROPER SUPERVISION, INSTALLATION, ADJUSTMENT, SERVICING, MAINTENANCE OR REPAIR OF THE EQUIPMENT SPECIFIED IN THIS MANUAL, OR ATTEMPTING TO INSTALL, ADJUST, SERVICE OR REPAIR THE EQUIPMENT SPECIFIED IN THIS MANUAL WITHOUT PROPER SUPERVISION OR TRAINING MAY RESULT IN PRODUCT DAMAGE, PROPERTY DAMAGE, PERSONAL INJURY OR DEATH.



WARNING

DO NOT BYPASS SAFETY DEVICES.



CAUTION

SCROLL EQUIPPED UNITS SHOULD NEVER BE USED TO EVACUATE THE AIR CONDITIONING SYSTEM. VACUUMS THIS LOW CAN CAUSE INTERNAL ELECTRICAL ARCING RESULTING IN A DAMAGED OR FAILED COMPRESSOR.

SHIPPING INSPECTION

Always keep the unit upright; laying the unit on its side or top may cause equipment damage. Shipping damage, and subsequent investigation is the responsibility of the carrier. Verify the model number, specifications, electrical characteristics, and accessories are correct prior to installation. The distributor or manufacturer will not accept claims from dealers for transportation damage or installation of incorrectly shipped units.

CODES & REGULATIONS

This product is designed and manufactured to comply with national codes. Installation in accordance with such codes and/or prevailing local codes/regulations is the responsibility of the installer. The manufacturer assumes no responsibility for equipment installed in violation of any codes or regulations. Rated performance is achieved after 20 hours of operation. Rated performance is delivered at the specified airflow. See outdoor unit specification sheet for split system models or product specification sheet for packaged and light commercial models. Specification sheets can be found at www.goodmanmfg.com for Goodman® brand products or www.amana-hac.com for Amana® brand products. Within either website, please select the residential or commercial products menu and then select the submenu for the type of product to be installed, such as air conditioners or heat pumps, to access a list of product pages that each contain links to that model's specification sheet.

The United States Environmental Protection Agency (EPA) has issued various regulations regarding the introduction and disposal of refrigerants. Failure to follow these regulations may harm the environment and can lead to the imposition of substantial fines.

19001 Kermier Rd., Waller, TX 77484

www.goodmanmfg.com • www.amana-hac.com

© 2021-2023 Daikin Comfort Technologies Manufacturing, L.P.

Amana is a registered trademark of Maytag Corporation or its related companies and is used under license. All rights reserved.



NOTICE: This unit is equipped with a 24 VAC transformer that powers the heat pump control board. When installed as a communicating system, only 2 wires are needed between indoor and outdoor equipment. However, when installed as a non-communicating (legacy) system, the transformer wiring (low voltage and line voltage) must be disconnected. Refer to the low voltage wiring section for more details.

Should you have any questions please contact the local office of the EPA.

If replacing a condensing unit or air handler, the system must be manufacturer approved and Air Conditioning, Heating and Refrigeration Institute (AHRI) matched.

NOTE: INSTALLATION OF UNMATCHED SYSTEM IS NOT ALLOWED.

Outdoor units are approved for operation above 55°F in cooling mode. Communicating units are equipped with two speed of ECM fan motors and are not approved for use with low ambient kits.

Damage to the unit caused by operating the unit in a structure that is not complete (either as part of new construction or renovation) is not covered by the warranty.

FEATURES

This heat pump is part of a **ComfortBridge™** control system designed to more efficiently control heat gain/loss with better efficiency and achieve targeted comfort conditions. The system utilizes digital linkage between the indoor and outdoor equipment and can be controlled by any single-stage thermostat. The **ComfortBridge™** control system reduces the number of required thermostat wires, provides additional setup features and enhanced active diagnostics through Bluetooth connectivity with the downloadable **CoolCloud™** app.

INSTALLATION CLEARANCES

Special consideration must be given to location of the condensing unit(s) in regard to structures, obstructions, other units, and any/all other factors that may interfere with air circulation. Where possible, the top of the unit should be completely unobstructed; however, if vertical conditions require placement beneath an obstruction **there should be a minimum of 60 inches between the top of the unit and the obstruction(s)**. The specified dimensions meet requirements for air circulation only. Consult all appropriate regulatory codes prior to determining final clearances.

Another important consideration in selecting a location for the unit(s) is the angle to obstructions. Either side adjacent the valves can be placed toward the structure provided the side away from the structure maintains minimum service clearance. Corner installations are strongly discouraged.

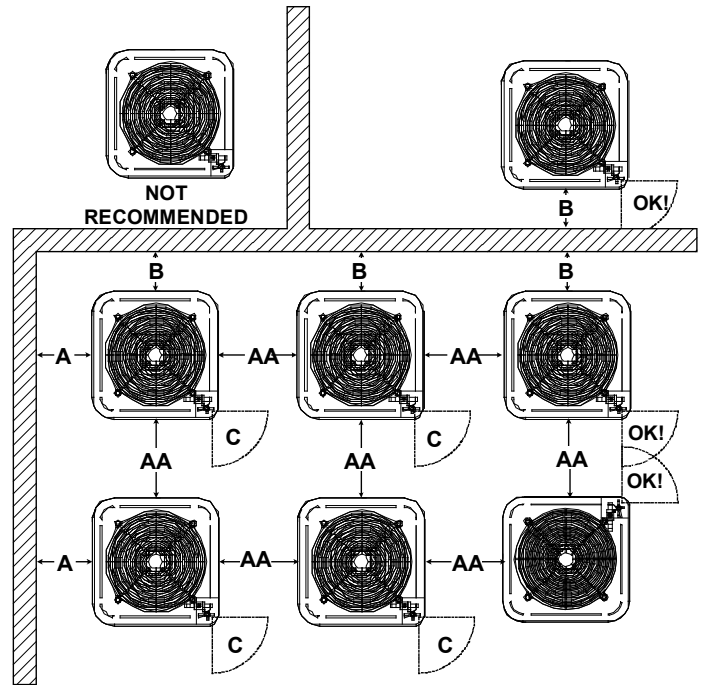

| Minimum Airflow Clearance | | | | |
|---------------------------|-----|-----|-----|-----|
| Model Type | A | B | C | AA |
| Residential | 10" | 10" | 18" | 20" |
| Light Commercial | 12" | 12" | 18" | 24" |

This unit can be located at ground floor level or on flat roofs. At ground floor level, the unit must be on a solid, level foundation that will not shift or settle. To reduce the possibility of sound transmission, the foundation slab should not be in contact with or be an integral part of the building foundation. The dimensions of the space necessary for correct installation of the appliance, including the minimum permissible distance to adjacent structures, have been covered in this section (per UL 60335-2-40). Ensure the foundation is sufficient to support the unit. A concrete slab raised above ground level provides a suitable base.

ROOFTOP INSTALLATIONS

If it is necessary to install this unit on a roof structure, ensure the roof structure can support the weight and that proper consideration is given to the weather-tight integrity of the roof. Since the unit can vibrate during operation, sound vibration transmission should be considered when installing the unit. Vibration absorbing pads or springs can be installed between the condensing unit legs or frame and the roof mounting assembly to reduce noise vibration.

NOTE: THESE UNITS REQUIRE SPECIAL LOCATION CONSIDERATION IN AREAS OF HEAVY SNOW ACCUMULATION AND/OR AREAS WITH PROLONGED CONTINUOUS SUBFREEZING TEMPERATURES. HEAT PUMP UNIT BASES HAVE CUTOUTS UNDER THE OUTDOOR COIL THAT PERMIT DRAINAGE OF FROST ACCUMULATION. SITUATE THE UNIT TO PERMIT FREE UNOBSTRUCTED DRAINAGE OF THE DEFROST WATER AND ICE. A MINIMUM 3" CLEARANCE UNDER THE OUTDOOR COIL IS REQUIRED IN THE MILD CLIMATES.

In more severe weather locations, it is recommended that the unit be elevated to allow unobstructed drainage and air flow. The elevation minimums at right are recommended:

| Design Temperature | Suggested Minimum Elevation |
|--------------------|-----------------------------|
| +15° and above | 2 1/2" |
| -5° to +14° | 8" |
| below -5° | 12" |

SAFE REFRIGERANT HANDLING

While these items will not cover every conceivable situation, they should serve as a useful guide.

| |
|--|
|  WARNING |
| TO AVOID POSSIBLE INJURY, EXPLOSION OR DEATH, PRACTICE SAFE HANDLING OF REFRIGERANTS. |

| |
|--|
|  WARNING |
| REFRIGERANTS ARE HEAVIER THAN AIR. THEY CAN "PUSH OUT" THE OXYGEN IN YOUR LUNGS OR IN ANY ENCLOSED SPACE. TO AVOID POSSIBLE DIFFICULTY IN BREATHING OR DEATH: |
| <ul style="list-style-type: none"> • NEVER PURGE REFRIGERANT INTO AN ENCLOSED ROOM OR SPACE. BY LAW, ALL REFRIGERANTS MUST BE RECLAIMED. • IF AN INDOOR LEAK IS SUSPECTED, THOROUGHLY VENTILATE THE AREA BEFORE BEGINNING WORK. • LIQUID REFRIGERANT CAN BE VERY COLD. TO AVOID POSSIBLE FROSTBITE OR BLINDNESS, AVOID CONTACT AND WEAR GLOVES AND GOGGLES. IF LIQUID REFRIGERANT DOES CONTACT YOUR SKIN OR EYES, SEEK MEDICAL HELP IMMEDIATELY. • ALWAYS FOLLOW EPA REGULATIONS. NEVER BURN REFRIGERANT, AS POISONOUS GAS WILL BE PRODUCED. |

| |
|--|
|  WARNING |
| TO AVOID POSSIBLE EXPLOSION: |
| <ul style="list-style-type: none"> • NEVER APPLY FLAME OR STEAM TO A REFRIGERANT CYLINDER. IF YOU MUST HEAT A CYLINDER FOR FASTER CHARGING, PARTIALLY IMMERSE IT IN WARM WATER. • NEVER FILL A CYLINDER MORE THAN 80% FULL OF LIQUID REFRIGERANT. • NEVER ADD ANYTHING OTHER THAN R-22 TO AN R-22 CYLINDER OR R-410A TO AN R-410A CYLINDER. THE SERVICE EQUIPMENT USED MUST BE LISTED OR CERTIFIED FOR THE TYPE OF REFRIGERANT USED. • STORE CYLINDERS IN A COOL, DRY PLACE. NEVER USE A CYLINDER AS A PLATFORM OR A ROLLER. |

| |
|--|
|  WARNING |
| TO AVOID POSSIBLE EXPLOSION, USE ONLY RETURNABLE (NOT DISPOSABLE) SERVICE CYLINDERS WHEN REMOVING REFRIGERANT FROM A SYSTEM. |
| <ul style="list-style-type: none"> • ENSURE THE CYLINDER IS FREE OF DAMAGE WHICH COULD LEAD TO A LEAK OR EXPLOSION. • ENSURE THE HYDROSTATIC TEST DATE DOES NOT EXCEED 5 YEARS. • ENSURE THE PRESSURE RATING MEETS OR EXCEEDS 400 PSIG. WHEN IN DOUBT, DO NOT USE CYLINDER. |

REFRIGERANT LINES

| |
|---|
|  CAUTION |
| THE COMPRESSOR POE OIL FOR R-410A UNITS IS EXTREMELY SUSCEPTIBLE TO MOISTURE ABSORPTION AND COULD CAUSE COMPRESSOR FAILURE. DO NOT LEAVE SYSTEM OPEN TO ATMOSPHERE ANY LONGER THAN NECESSARY FOR INSTALLATION. |

| |
|--|
|  WARNING |
| PARTIAL UNITS SHALL ONLY BE CONNECTED TO AN APPLIANCE SUITABLE FOR THE SAME REFRIGERANT. |

For evaporating and condensing units, any instructions or markings **MUST** include wording to ensure that the maximum operating pressure is considered before connecting to any condenser or evaporator unit (per UL 60335-2-40).

Use only refrigerant grade (dehydrated and sealed) copper tubing to connect the condensing unit with the indoor evaporator. After cutting the tubing, install plugs to keep refrigerant tubing clean and dry prior to and during installation. Tubing should always be cut square keeping ends round and free from burrs. Clean the tubing to prevent contamination.

Do NOT let refrigerant lines come in direct contact with plumbing, ductwork, floor joists, wall studs, floors, and walls. When running refrigerant lines through a foundation or wall, openings should allow for sound and vibration absorbing material to be placed or installed between tubing and foundation. Any gap between foundation or wall and refrigerant lines should be filled with a pliable silicon-based caulk, RTV or a vibration damping material. Avoid suspending refrigerant tubing from joists and studs with rigid wire or straps that would come in contact with the tubing. Use an insulated or suspension type hanger. Keep both lines separate and always insulate the suction line.

These sizes are suitable for line lengths of 79 feet or less. If a run of more than eighty feet is required, refer to TP-107 Long Line Set Application R-410A or contact your distributor for assistance.

This is a partial unit air conditioner and complies with the international standards of partial unit requirements. It **MUST** only be connected to other units that have been confirmed to comply with the international standards of partial unit requirements (per UL 60335-2-40).

| RECOMMENDED INTERCONNECTING TUBING (Ft) | | | | | | |
|---|------------------------|-----|-------|-----|--------|-----|
| Cond Unit Tons | 0-24 | | 25-49 | | 50-79* | |
| | Line Diameter (In. OD) | | | | | |
| | Suct | Liq | Suct | Liq | Suct | Liq |
| 1 1/2 | 5/8 | 1/4 | 3/4 | 3/8 | 3/4 | 3/8 |
| 2 | 5/8 | 1/4 | 3/4 | 3/8 | 3/4 | 3/8 |
| 2 1/2 | 5/8 | 1/4 | 3/4 | 3/8 | 7/8 | 3/8 |
| 3 | 3/4 | 3/8 | 7/8 | 3/8 | 1 1/8 | 3/8 |
| 3 1/2 | 7/8 | 3/8 | 1 1/8 | 3/8 | 1 1/8 | 3/8 |
| 4 | 7/8 | 3/8 | 1 1/8 | 3/8 | 1 1/8 | 3/8 |
| 5 | 7/8 | 3/8 | 1 1/8 | 3/8 | 1 1/8 | 3/8 |

* Lines greater than 79 feet in length or vertical elevation changes more than 50 feet refer to the TP-107 R-410A Long Line Set Application Guidelines or contact your distributor for assistance.

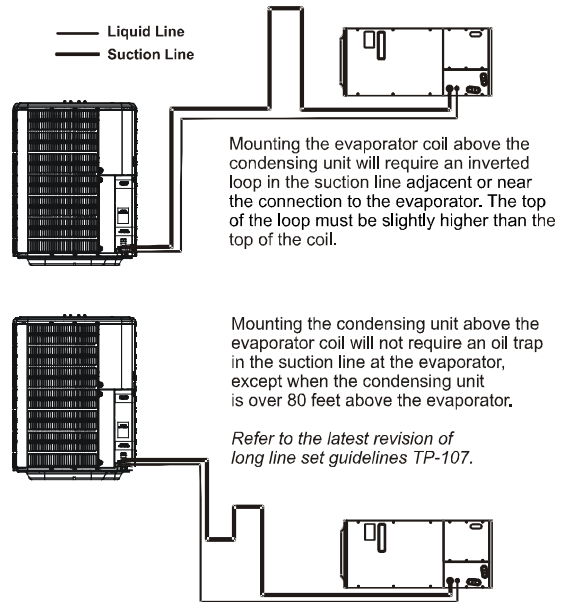

BURYING REFRIGERANT LINES

Insulation is necessary to prevent condensation from forming and dripping from the suction line. Armaflex (or satisfactory equivalent) with 3/8" min. wall thickness is recommended. In severe conditions (hot, high humidity areas) 1/2" insulation may be required. Insulation must be installed in a manner which protects tubing from damage and contamination.

If burying refrigerant lines can not be avoided, use the following checklist.

1. Insulate liquid and suction lines separately.
2. Enclose all underground portions of the refrigerant lines in waterproof material (conduit or pipe) sealing the ends where tubing enters/exits the enclosure.
3. If the lines must pass under or through a concrete slab, ensure lines are adequately protected and sealed.

EXISTING LINE SETS

Where possible, drain as much residual compressor oil from existing systems, lines, and traps; pay close attention to low areas where oil may collect. Use of an approved flushing agent is recommended followed by a nitrogen purge to remove any remaining flushing agent from the lines or indoor coil. Replacement of indoor coil is recommended.

NOTE: IF USING EXISTING INDOOR COIL AND CHANGING REFRIGERANT TYPES, ENSURE THE INDOOR COIL AND METERING DEVICE ARE COMPATIBLE WITH THE TYPE OF REFRIGERANT BEING USED. IF NEW INDOOR COIL IS REQUIRED CHECK SPEC SHEET OR AHRI FOR APPROVED COIL. IF SYSTEM IS BEING REPLACED DUE TO COMPRESSOR ELECTRICAL FAILURE, ASSUME ACID IS IN SYSTEM. REFER TO SERVICE PROCEDURE S-115 COMPRESSOR BURNOUT IN SERVICE MANUAL FOR CLEAN-UP PROCEDURE.

REFRIGERANT LINE CONNECTIONS

IMPORTANT

To avoid overheating the service valve, TXV valve, or filter drier while brazing, wrap the component with a wet rag, or use a thermal heat trap compound. Be sure to follow the manufacturer's instruction when using the heat trap compound. **NOTE: Remove Schrader valves from service valves before brazing tubes to the valves. Use a brazing alloy of 2% minimum silver content. Do not use flux.**

Torch heat required to braze tubes of various sizes is proportional to the size of the tube. Tubes of smaller size require less heat to bring the tube to brazing temperature before adding brazing alloy. Applying too much heat to any tube can melt the tube. Service personnel must use the appropriate heat level for the size of the tube being brazed. **NOTE: The use of a heat shield when brazing is recommended to avoid burning the serial plate or the finish on the unit.**

1. The ends of the refrigerant lines must be cut square, deburred, cleaned, and be round and free from nicks or dents. Any other condition increases the chance of a refrigerant leak.

2. "Sweep" the refrigerant line with nitrogen or inert gas during brazing to prevent the formation of copper-oxide inside the refrigerant lines. The POE oils used in R-410A applications will clean any copper-oxide present from the inside of the refrigerant lines and spread it throughout the system. This may cause a blockage or failure of the metering device.
3. After brazing, quench the joints with water or a wet cloth to prevent overheating of the service valve.
4. Ensure the filter drier paint finish is intact after brazing. If the paint of the steel filter drier has been burned or chipped, repaint or treat with a rust preventative. This is especially important on suction line filter driers which are continually wet when the unit is operating.

NOTE: BE CAREFUL NOT TO KINK OR DENT REFRIGERANT LINES. KINKED OR DENTED LINES WILL CAUSE POOR PERFORMANCE OR COMPRESSOR DAMAGE.

Do NOT make final refrigerant line connection until plugs are removed from refrigerant tubing.

NOTE: BEFORE BRAZING, VERIFY INDOOR TXV IS CORRECT FOR R410A AND PROPER SIZE.

LEAK TESTING (NITROGEN OR NITROGEN-TRACED)

| |
|--|
|  WARNING |
| <p>TO AVOID THE RISK OF FIRE OR EXPLOSION, NEVER USE OXYGEN, HIGH PRESSURE AIR OR FLAMMABLE GASES FOR LEAK TESTING OF A REFRIGERATION SYSTEM.</p> |

| |
|---|
|  WARNING |
| <p>TO AVOID POSSIBLE EXPLOSION, THE LINE FROM THE NITROGEN CYLINDER MUST INCLUDE A PRESSURE REGULATOR AND A PRESSURE RELIEF VALVE. THE PRESSURE RELIEF VALVE MUST BE SET TO OPEN AT NO MORE THAN 450 PSIG.</p> |

Using dry nitrogen, pressurize the system to 450 PSIG. Allow the pressure to stabilize and hold for 15 minutes (minimum). If the pressure does not drop below 450 PSIG the system is considered leak free. Proceed to system evacuation using the Deep Vacuum Method. If after 15 minutes the pressure drops below 450 PSIG follow the procedure outlined below to identify system leaks. Repeat the Standing Pressure Test.

Leak Test the system using dry nitrogen and soapy water to identify leaks. If you prefer to use an electronic leak detector, charge the system to 10 PSIG with the appropriate system refrigerant (see Serial Data Plate for refrigerant identification). Do not use an alternative refrigerant. Using dry nitrogen finish charging the system to 450 PSIG. Apply the leak detector to all suspect areas.

When leaks are discovered, repair the leaks, and repeat the pressure test. If leaks have been eliminated proceed to system evacuation.

SYSTEM EVACUATION

Condensing unit liquid and suction valves are closed to contain the charge within the unit. The unit is shipped with the valve stems closed and caps installed. **Do not open valves until the system is evacuated.**

| |
|--|
|  WARNING |
| <p>REFRIGERANT UNDER PRESSURE! FAILURE TO FOLLOW PROPER PROCEDURES MAY CAUSE PROPERTY DAMAGE, PERSONAL INJURY OR DEATH.</p> |

NOTE: SCROLL COMPRESSORS SHOULD NEVER BE USED TO EVACUATE OR PUMP DOWN A HEAT PUMP OR AIR CONDITIONING SYSTEM.

| |
|---|
|  CAUTION |
| <p>PROLONGED OPERATION AT SUCTION PRESSURES LESS THAN 20 PSIG FOR MORE THAN 5 SECONDS WILL RESULT IN OVERHEATING OF THE SCROLLS AND PERMANENT DAMAGE TO THE SCROLL TIPS, DRIVE BEARINGS AND INTERNAL SEAL.</p> |

DEEP VACUUM METHOD (RECOMMENDED)

The Deep Vacuum Method requires a vacuum pump rated for 500 microns or less. This method is an effective and efficient way of assuring the system is free of non-condensable air and moisture. As an alternative, the Triple Evacuation Method is detailed in the Service Manual for this product model.



It is recommended to remove the Schrader Cores from the service valves using a core-removal tool to expedite the evacuation procedure.

1. Connect the vacuum pump, micron gauge, and vacuum rated hoses to both service valves. Evacuation must use both service valves to eliminate system mechanical seals.
2. Evacuate the system to less than 500 microns.
3. Isolate the pump from the system and hold vacuum for 10 minutes (minimum). Typically, pressure will rise slowly during this period. If the pressure rises to less than 1000 microns and remains steady, the system is considered leak-free; proceed to system charging and startup.
4. If pressure rises above 1000 microns but holds steady below 2000 microns, non-condensable air or moisture may remain or a small leak is present. Return to step 2: If the same result is achieved check for leaks and repair. Repeat the evacuation procedure.

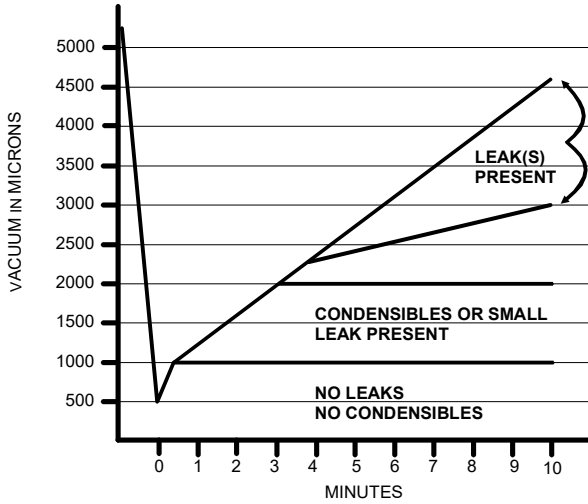
- If pressure rises above 2000 microns, a leak is present. Check for leaks and repair. Repeat the evacuation procedure.



ELECTRICAL CONNECTIONS

| |
|--|
|  WARNING |
| <p>HIGH VOLTAGE! DISCONNECT ALL POWER BEFORE SERVICING. MULTIPLE POWER SOURCES MAY BE PRESENT. FAILURE TO DO SO MAY CAUSE PROPERTY DAMAGE, PERSONAL INJURY OR DEATH DUE TO ELECTRICAL SHOCK. WIRING MUST CONFORM WITH NEC OR CEC AND ALL LOCAL CODES. UNDERSIZED WIRES COULD CAUSE POOR EQUIPMENT PERFORMANCE, EQUIPMENT DAMAGE OR FIRE.</p>  |
|  WARNING |
| <p>TO AVOID THE RISK OF FIRE OR EQUIPMENT DAMAGE, USE COPPER CONDUCTORS.</p> |

The condensing unit rating plate lists pertinent electrical data necessary for proper electrical service and overcurrent protection. Wires should be sized to limit voltage drop to 2% (max.) from the main breaker or fuse panel to the condensing unit. Consult the NEC, CEC, and all local codes to determine the correct wire gauge and length. This appliance **MUST** be installed in accordance with national wiring regulations (per UL 60335-2-40).

Local codes often require a disconnect switch located near the unit; do not install the switch on the unit. Refer to the installation instructions supplied with the indoor furnace/air handler for specific wiring connections and indoor unit configuration. Likewise, consult the instructions packaged with the thermostat for mounting and location information.

OVERCURRENT PROTECTION

The following overcurrent protection devices are approved for use.

- Time delay fuses
- HACR type circuit breakers

These devices have sufficient time delay to permit the motor-compressor to start and accelerate its load.

HIGH VOLTAGE CONNECTIONS

Route power supply and ground wires through the high voltage port and terminate in accordance with the wiring diagram provided inside the control panel cover.

LOW VOLTAGE CONNECTIONS

This heat pump is equipped with a factory-installed transformer to power the outdoor controls when installed as part of a fully communicating HVAC system utilizing a **ComfortBridge™** compatible indoor unit. In this configuration, only two low voltage control wires are required between the outdoor unit and indoor unit.

The unit also has legacy 24 VAC inputs and outputs to support non-communicating systems. When this configuration is used, the transformer in the outdoor unit must be disconnected from the low voltage and line voltage connections. The transformer connecting wires can then be discarded. Route control wires through the low voltage port and terminate in accordance with the wiring diagram provided inside the control panel cover.

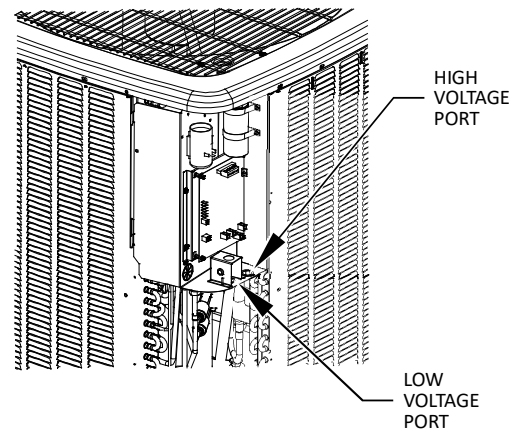

VOLTAGE PORTS

NOTE: FOR TWO-STAGE UNITS, REFER TO THE INSTALLATION INSTRUCTIONS SUPPLIED WITH THE VARIABLE SPEED INDOOR UNITS FOR FIELD WIRING CONNECTIONS.

NOTE: IF THE HEAT PUMP UNIT IS WIRED IN THE COMMUNICATING MODE TOGETHER WITH A COMPATIBLE COMMUNICATING INDOOR UNIT, THEN THE COMMUNICATING EQUIPMENT IS ABLE TO SEARCH AND IDENTIFY THE CONDENSING UNIT WHEN POWER IS APPLIED TO THE SYSTEM. REFER TO THE INSTALLATION MANUAL OF THE COMMUNICATING INDOOR EQUIPMENT FOR MORE INFORMATION.

For non-communicating (legacy 24VAC) installations, use the dipswitch to select defrost time interval (30, 60, 90, 120 minutes; see chart below).

Factory default setting is 30 minutes. The maximum defrost cycle time is 10 minutes.

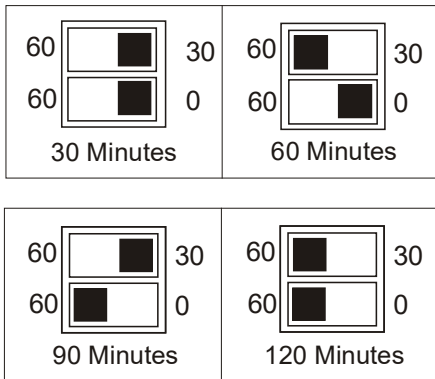

DIPSWITCH SETTINGS FOR SELECTION OF DEFROST TIME

SYSTEM START UP

| | |
|---|----------------|
| | WARNING |
| <p>HIGH VOLTAGE! DISCONNECT ALL POWER BEFORE SERVICING OR INSTALLING THIS UNIT. MULTIPLE POWER SOURCES MAY BE PRESENT. FAILURE TO DO SO MAY CAUSE PROPERTY DAMAGE, PERSONAL INJURY OR DEATH.</p> | |
| | |

| | |
|---|----------------|
| | CAUTION |
| <p>POSSIBLE REFRIGERANT LEAK! TO AVOID A POSSIBLE REFRIGERANT LEAK, OPEN THE SERVICE VALVES UNTIL THE TOP OF THE STEM IS 1/8" FROM THE RETAINER.</p> | |

NOTE: POWER MUST BE SUPPLIED TO THE 18 SEER OUTDOOR UNITS CONTAINING ECM MOTORS BEFORE THE POWER IS APPLIED TO THE INDOOR UNIT. SENDING A LOW VOLTAGE SIGNAL WITHOUT HIGH VOLTAGE POWER PRESENT AT THE OUTDOOR UNIT CAN CAUSE MALFUNCTION OF THE CONTROL MODULE ON THE ECM MOTOR.

Adequate refrigerant charge for the matching evaporator coil or air handler and 15 feet of lineset is supplied with the condensing unit. If using evaporator coils or air handlers other than HSVTC coil it maybe necessary to add or remove refrigerant to attain proper charge. If line set exceeds 15 feet in length, refrigerant should be added at .6 ounces per foot of liquid line.

NOTE: CHARGE SHOULD ALWAYS BE CHECKED USING SUPERHEAT WHEN USING A PISTON AND SUBCOOLING WHEN USING TXV EQUIPPED INDOOR COIL TO VERIFY PROPER CHARGE.

Break vacuum by fully opening liquid service valve. After the refrigerant charge has bled into the system, open the suction service valve. The service valve cap is the secondary seal for the valves and must be properly tightened to prevent leaks. Make sure cap is clean and apply refrigerant oil to threads and sealing surface on inside of cap. Tighten cap finger-tight and then tighten additional 1/8 of a turn (1 wrench flat), or to the following specification, to properly seat the sealing surfaces.

When opening valves with retainers, open each valve only until the top of the stem is 1/8" from the retainer. To avoid loss of refrigerant, DO NOT apply pressure to the retainer. When opening valves without a retainer remove service valve cap and insert a hex wrench into the valve stem and back out the stem by turning the hex wrench counterclockwise. Open the valve until it contacts the rolled lip of the valve body.

NOTE: THESE ARE NOT BACK-SEATING VALVES. IT IS NOT NECESSARY TO FORCE THE STEM TIGHTLY AGAINST THE ROLLED LIP.

After the refrigerant charge has bled into the system, open the liquid service valve. The service valve cap is the secondary seal for the valve and must be properly tightened to prevent leaks. Make sure cap is clean and apply refrigerant oil to threads and sealing surface on inside of cap. Tighten cap finger-tight and then tighten additional 1/8 of a turn (1 wrench flat) to properly seat the sealing surfaces.

Do not introduce liquid refrigerant from the cylinder into the crankcase of the compressor as this may damage the compressor.

1. Break vacuum by fully opening liquid and suction base valves.
2. Set thermostat to call for cooling. Check indoor and outdoor fan operation and allow system to stabilize for 10 minutes for fixed orifices and 20 minutes for expansion valves.

CHARGE VERIFICATION



WARNING

REFRIGERANT UNDER PRESSURE!

- Do not overcharge system with refrigerant.
- Do not operate unit in a vacuum or at negative pressure.

FAILURE TO FOLLOW PROPER PROCEDURES MAY CAUSE PROPERTY DAMAGE, PERSONAL INJURY OR DEATH.



CAUTION

USE REFRIGERANT CERTIFIED TO AHRI STANDARDS. USED REFRIGERANT MAY CAUSE COMPRESSOR DAMAGE, AND IS NOT COVERED UNDER THE WARRANTY. MOST PORTABLE MACHINES CANNOT CLEAN USED REFRIGERANT TO MEET AHRI STANDARDS.

NOTICE

VIOLATION OF EPA REGULATIONS MAY RESULT IN FINES OR OTHER PENALTIES.



CAUTION

DAMAGE TO THE UNIT CAUSED BY OPERATING THE COMPRESSOR WITH THE SUCTION VALVE CLOSED IS NOT COVERED UNDER THE WARRANTY AND MAY CAUSE SERIOUS COMPRESSOR DAMAGE.

FINAL CHARGE ADJUSTMENT

Airflow and Total Static Pressure for the indoor unit should be verified before attempting to charge system.

1. Total static pressure is .5" WC or less.
2. Airflow is correct for installed unit.
3. Airflow tables are in the installation manual and Spec Sheet for Indoor Unit.
4. Complete charging information, including instructions on charging refrigerants when the addition of a charge is required by the manufacturer to complete the refrigerant system, can be found in Service Manual RS6200007.

NOTE: SUPERHEAT ADJUSTMENTS SHOULD NOT BE MADE UNTIL INDOOR AMBIENT CONDITIONS HAVE STABILIZED. THIS COULD TAKE UP TO 24 HOURS DEPENDING ON INDOOR TEMPERATURE AND HUMIDITY. BEFORE CHECKING SUPERHEAT RUN THE UNIT IN COOLING FOR 10-15 MINUTES OR UNTIL REFRIGERANT PRESSURES STABILIZE. USE THE FOLLOWING GUIDELINES AND METHODS TO CHECK UNIT OPERATION AND ENSURE THAT THE REFRIGERANT CHARGE IS WITHIN LIMITS.

| SATURATED SUCTION PRESSURE TEMPERATURE CHART | |
|--|----------------------------------|
| SUCTION PRESSURE | SATURATED SUCTION TEMPERATURE °F |
| PSIG | R-410A |
| 50 | 1 |
| 52 | 3 |
| 54 | 4 |
| 56 | 6 |
| 58 | 7 |
| 60 | 8 |
| 62 | 10 |
| 64 | 11 |
| 66 | 13 |
| 68 | 14 |
| 70 | 15 |
| 72 | 16 |
| 74 | 17 |
| 76 | 19 |
| 78 | 20 |
| 80 | 21 |
| 85 | 24 |
| 90 | 26 |
| 95 | 29 |
| 100 | 31 |
| 110 | 36 |
| 120 | 41 |
| 130 | 45 |
| 140 | 49 |
| 150 | 53 |
| 160 | 56 |
| 170 | 60 |

EXPANSION VALVE SYSTEM



CAUTION

TO PREVENT PERSONAL INJURY, CAREFULLY CONNECT AND DISCONNECT MANIFOLD GAUGE HOSES. ESCAPING LIQUID REFRIGERANT CAN CAUSE BURNS. DO NOT VENT REFRIGERANT INTO THE ATMOSPHERE. RECOVER ALL REFRIGERANT DURING SYSTEM REPAIR AND BEFORE FINAL UNIT DISPOSAL.

NOTE: UNITS MATCHED WITH INDOOR COILS EQUIPPED WITH NON-ADJUSTABLE TXV SHOULD BE CHARGED BY SUBCOOLING ONLY.

Run the unit on low stage cooling for 10 minutes until refrigerant pressures stabilize. Use the following guidelines and methods to check unit operation and ensure that the refrigerant charge is within limits. **NOTE: Charge the unit on low stage.**

1. Purge the gauge lines and connect the service gauge manifold to the base valve service ports.

2. Clamp a pipe clamp thermometer on the liquid line near the liquid line service valve and 4-6" from the compressor on the suction line.
 - a. Ensure the thermometer makes adequate contact to obtain the best possible readings.
 - b. The temperature read with the thermometer should be lower than the saturated condensing temperature.

| SATURATED LIQUID PRESSURE TEMPERATURE CHART | |
|---|---------------------------------|
| LIQUID PRESSURE | SATURATED LIQUID TEMPERATURE °F |
| PSIG | R-410A |
| 200 | 69 |
| 215 | 74 |
| 230 | 78 |
| 245 | 82 |
| 260 | 86 |
| 275 | 90 |
| 290 | 94 |
| 305 | 97 |
| 320 | 100 |
| 335 | 104 |
| 350 | 107 |
| 365 | 110 |
| 380 | 113 |
| 395 | 116 |
| 410 | 118 |
| 425 | 121 |
| 440 | 124 |
| 455 | 126 |
| 470 | 129 |
| 485 | 131 |
| 500 | 134 |
| 515 | 136 |
| 530 | 138 |
| 545 | 140 |
| 560 | 143 |
| 575 | 145 |
| 590 | 147 |
| 605 | 149 |
| 620 | 151 |
| 635 | 153 |
| 650 | 155 |

3. The difference between the measured saturated condensing temperature and the liquid line temperature is the liquid Subcooling value.

4. TXV-based systems should have a Subcooling value of 6°F +/- 1°F.
5. Add refrigerant to increase Subcooling and remove refrigerant to decrease Subcooling.

NOTE: UNITS MATCHED WITH INDOOR COILS EQUIPPED WITH A TXV SHOULD BE CHARGED BY SUBCOOLING ONLY. SUPERHEAT CAN ALSO BE UTILIZED TO BEST VERIFY CHARGE LEVELS WITH AN ADJUSTABLE TXV AND MAKE ADJUSTMENTS WHEN NEEDED IN UNIQUE APPLICATIONS DUE TO REFRIGERANT LINE LENGTH, DIFFERENCES IN HEIGHT BETWEEN THE INDOOR AND OUTDOOR UNIT AND REFRIGERANT TUBING SIZES. THESE ADJUSTMENTS SHOULD ONLY BE PERFORMED BY QUALIFIED SERVICE PERSONNEL.

ADVANCE ADJUSTMENT RECOMMENDATIONS

1. Clamp a pipe clamp thermometer near the suction line service valve at the outdoor unit.
 - a. Ensure the thermometer makes adequate contact for the best possible readings.
 - b. The temperature read with the thermometer should be higher than the saturated suction temperature.
2. The difference between the measured saturated suction temperature and the suction line temperature is the Superheat value.
3. TXV-based systems should have a Superheat value of 8°F +/- 1°F.
4. Adjust Superheat by turning the TXV valve stem clockwise to increase and counterclockwise to decrease.
 - a. If Subcooling and Superheat are low, adjust the TXV to 8°F +/- 1°F, and then check Subcooling.
 - b. If Subcooling is low and Superheat is high, addcharge to raise Subcooling to 6°F +/- 1°F then check Superheat.
 - c. If Subcooling and Superheat are high, adjust the TXV valve to 8°F +/- 1°F Superheat, then check the Subcooling value.
 - d. If Subcooling is high and Superheat is low, adjust the TXV valve to 8°F +/- 1°F Superheat and remove charge to lower the Subcooling to 6°F +/- 1°F.

NOTE: DO NOT ADJUST THE CHARGE BASED EXCLUSIVELY ON SUCTION PRESSURE UNLESS FOR GENERAL CHARGING IN THE CASE OF A GROSS UNDERCHARGE.

NOTE: CHECK THE SCHRADER PORTS FOR LEAKS AND TIGHTEN VALVE CORES IF NECESSARY. INSTALL CAPS FINGER-TIGHT.

HEAT PUMP - HEATING CYCLE

The proper method of charging a heat pump in the heat mode is by weight with the additional charge adjustments for line size, line length, and other system components. To achieve maximum performance, adjust the OD TXV to 8°F +/- 1°F superheat and subcool below 40° F at 4-6" from the compressor. Make final charge adjustments in the cooling cycle.

Low Speed Lock-Out: The outdoor system has a low speed lock-out feature. In communicating mode, below 37°F outdoor ambient, the system locks out low stage and operates only in high stage to provide maximum heating capacity.

ADDITIONAL NOTES

1. There are (3) 7-segment LED displays on the PCB. Refer to the Troubleshooting chart at the end of this manual for definitions of the LED status.
2. "TERM" dip switch is used for communications bus configuration. Leave the settings to the factory default position.
3. "LEARN" push button is used to reset the communications between the equipment. Used only for troubleshooting purposes.
4. Press "TEST" push button, during system "Standby" mode to turn on both the compressor and outdoor fan for five seconds.
5. The "RECALL" push button is used to retrieve the six most recent faults. The control must be in Standby Mode (no thermostat inputs) to use the feature. Depress the push button for approximately two seconds and less than five seconds. The 7-segment LED displays will then display the six most recent faults beginning with the most recent fault and decrementing to the least recent fault. The faults may be cleared by depressing the button for greater than five seconds. Consecutively repeated faults are displayed a maximum of three times. Refer to the fault code definitions at the end of this manual for more details.
6. A forced defrost can be initiated by pressing "TEST" and "RECALL" push buttons simultaneously for more than 1 second with a valid call for heat. The forced defrost can be terminated by
 - A 10 minute lapse in time,
 - A coil temperature rise above 75°F or
 - By pressing the two buttons again for more than 1 second.

COMFORTBRIDGE™ SYSTEM

OVERVIEW

The **ComfortBridge** based two stage heating and air conditioning system uses an indoor unit and outdoor unit digitally communicating with one another via a two-way communications path.

In a traditional system, the thermostat sends commands to the indoor and outdoor units via analog 24 VAC signals. It is a one-way communication path in that the indoor and outdoor units typically do not return information to the thermostat.

The indoor unit, and outdoor unit, comprising of a **ComfortBridge** system "communicate" digitally with one another creating a two-way communications path. The thermostat still sends commands to the indoor unit, however, the 24VAC indoor and outdoor unit may also request and receive information from one another to optimize system performance.

Two-way digital communications is accomplished using only two wires between the indoor and outdoor units. The heat pump control board is powered by 24 VAC, which is supplied by the factory-installed transformer in the heat pump control box.

AIRFLOW CONSIDERATION

Airflow demands are managed differently in a fully communicating system than they are in a legacy wired system. The system operating mode (as determined by the thermostat) determines which unit calculates the system airflow demand. If the indoor unit is responsible for determining the airflow demand, it calculates the demand and sends it to the ECM motor. If the outdoor unit or thermostat is responsible for determining the demand, it calculates the demand and transmits the demand along with a fan request to the indoor unit. The indoor unit then sends the demand to the ECM motor. The table below lists the various **ComfortBridge** compatible systems, the operating mode, and airflow demand source.

| System | System Operating Mode | Airflow Demand Source |
|-------------------------|---------------------------|--------------------------------------|
| Heat Pump + Air Handler | Cooling | Heat Pump |
| | Heat Pump Heating Only | Heat Pump |
| | HP + Electric Heat Strips | > of Heat Pump or Air Handler Demand |
| | Electric Heat Strips Only | Air Handler |
| | Continuous Fan | Thermostat |
| Heat Pump + Furnace | Cooling | Heat Pump |
| | Heat Pump Heating Only | Heat Pump |
| | Auxiliary Heating | Furnace |
| | Continuous Fan | Thermostat |

For example, assume the system is a heat pump matched with an air handler. With a call for low stage cooling, the heat pump will calculate the system's low stage cooling airflow demand. The heat pump will then send a fan request along with the low stage cooling airflow demand to the air handler. Once received, the air handler will send the low stage cooling airflow demand to the ECM motor. The ECM motor then delivers the low stage cooling airflow. The following table lists the nominal high and low stage airflow for the ComfortBridge heat pumps.

| Models | Cooling | | Heating | |
|------------|---------|------|--------------|------|
| | High | Low | High | Low |
| *SZC160241 | 800 | 600 | 800 | 600 |
| *SZC160361 | 1200 | 800 | 1200 | 800 |
| *SZC160481 | 1550 | 1100 | 1550 | 1100 |
| *SZC160601 | 1800 | 1210 | 1800 | 1210 |
| *SZC180241 | 850 | 550 | 850 | 550 |
| *SZC180361 | 1250 | 850 | 1250 <td 850 | |
| *SZC180481 | 1550 | 1210 | 1550 | 1210 |
| *SZC180601 | 1750 | 1210 | 1750 | 1210 |
| *SZC702410 | 800 | 600 | 800 | 600 |
| *SZC703610 | 1250 | 850 | 1250 | 850 |
| *SZC704810 | 1550 | 1210 | 1550 | 1210 |
| *SZC706010 | 1750 | 1210 | 1750 | 1210 |

CONTROL WIRING

NOTE: REFER TO SECTION ELECTRICAL CONNECTIONS - HIGH VOLTAGE CONNECTIONS FOR 208/230 VOLT LINE CONNECTIONS TO THE AIR CONDITIONER OR HEAT PUMP.

NOTE: A REMOVABLE PLUG CONNECTOR IS PROVIDED WITH THE CONTROL BOARD TO MAKE THERMOSTAT WIRE CONNECTIONS. THIS PLUG MAY BE REMOVED, WIRE CONNECTIONS MADE TO THE PLUG, AND REPLACED. IT IS STRONGLY RECOMMENDED THAT YOU DO NOT CONNECT MULTIPLE WIRES INTO A SINGLE TERMINAL. WIRE NUTS ARE RECOMMENDED TO ENSURE ONE WIRE IS USED FOR EACH TERMINAL. FAILURE TO DO SO MAY RESULT IN INTERMITTENT OPERATION.

Typical 18 AWG thermostat wire may be used to wire the system components. However, communications reliability may be improved by using a high quality, shielded, twisted pair cable for the data transmission lines. In either case, 150 feet is the maximum length of wire between indoor unit and outdoor unit, or between indoor unit and thermostat.

TWO-WIRE OUTDOOR

For communicating systems, only two wires are required between the indoor and outdoor units. This wiring scheme requires only the data lines, 1 and 2 between indoor and outdoor equipment.

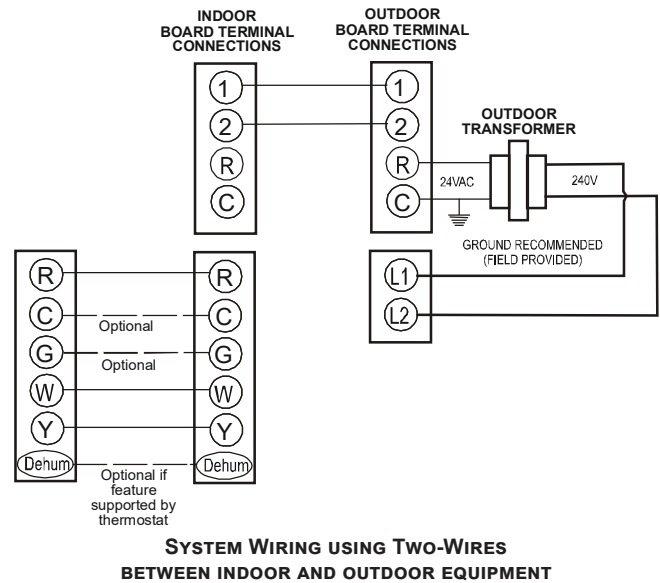

LEGACY CONTROLS WIRING

The integrated control board on this unit is factory-equipped with a 4-pin connector for low voltage controls wiring for communicating systems. If the system is installed as a non-communicating (legacy) system, remove the 4-pin connector and disconnect the transformer low voltage and line voltage wiring. Then, install the 7-pin connector that is supplied in the literature/accessories bag into the integrated control board in the appropriate location indicated by the color-coded labels found on both the control board and pin connector plug.

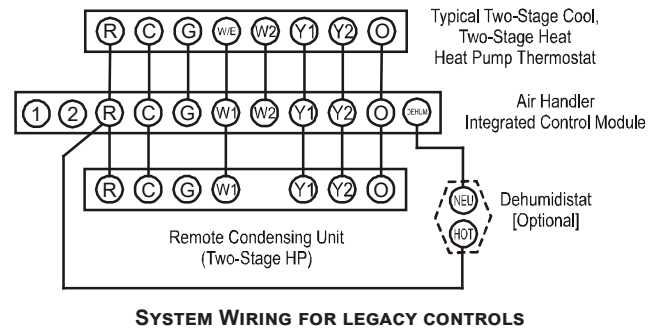

COMFORTBRIDGE™ SYSTEM ADVANCED FEATURES

The ComfortBridge system permits access to additional system information, advanced set-up features, and advanced diagnostic/troubleshooting features via the control board push buttons or the **CoolCloud** mobile app.

FAULT CODE HISTORY

Accessing the air conditioner/heat pump's diagnostics menu provides ready access to the last six faults detected by the air conditioner/heat pump. Faults are stored most recent to least recent. Any consecutively repeated fault is stored a maximum of three times. Example: The power supply to the air conditioner/heat pump is continuously below 187 VAC. The control will only store this fault the first three consecutive times the fault occurs.

NOTE: IT IS HIGHLY RECOMMENDED THAT THE FAULT HISTORY BE CLEARED AFTER PERFORMING MAINTENANCE OR SERVICING THE HEAT PUMP.

IDENTIFICATION

Model Number, Serial Number and Software Version are displayed within this menu. A model number check will help determine if the equipment shared data is correct for the unit. *If the model number is not correct or no serial number is visible, even though very rare, memory cards are available to load the proper data.*

SENSOR DATA

The outdoor ambient temperature and coil temperature are displayed in the Sensor Data Menu. This information can be used for troubleshooting purposes.

DEVICE SETTINGS

This menu allows for the adjustment of several cooling performance variables. Cool Airflow Trim (range from -10% to 10% in 2% increments), Cool Airflow Profiles, Cool Fan ON Delay, Cool Fan OFF Delay and Dehumidification Select (enable or disable dehumidification) can be adjusted in this menu. See the following images showing the four cooling airflow profiles.

- **Profile A** (default) provides only an OFF delay of one (1) minute at 100% of the cooling demand airflow.

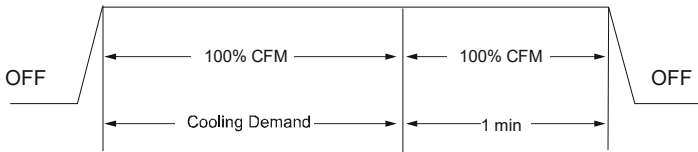

- **Profile B** ramps up to full cooling demand airflow by first stepping up to 50% of the full demand for 30 seconds. The motor then ramps to 100% of the required airflow. A one (1) minute OFF delay at 100% of the cooling airflow.

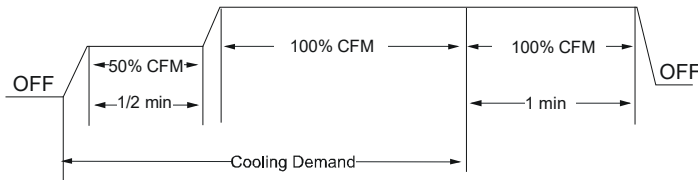

- **Profile C** ramps up to 82% of the full cooling demand airflow and operates there for approximately 7 1/2 minutes. The motor then steps up to the full demand airflow. Profile C also has a one (1) minute 100% OFF delay.

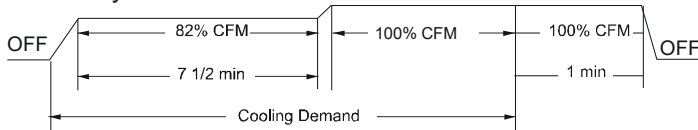

- **Profile D** ramps up to 50% of the demand for 1/2 minute, then ramps to 82% of the full cooling demand airflow and operates there for approximately 7 1/2 minutes. The motor then steps up to the full demand airflow. Profile D has a 1/2 minute at 50% airflow OFF delay.

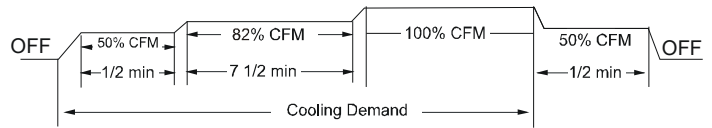

AIRFLOW TABLES

HEAT SET-UP

This menu allows for the adjustment of several heating performance variables. Heat Airflow Trim (range from -10% to 10% in 2% increments), Heat Fan ON Delay, Heat Fan OFF Delay, Defrost Interval and Compressor Delay can be adjusted in this menu. Defrost Interval determines the amount of compressor run time between defrost cycles. Compressor delay selects a compressor off time after a reversing valve shift.

DEVICE STATUS

The current system operational mode and requested indoor CFM is reported in this menu. This information can be used for troubleshooting purposes.

THERMOSTAT MENU

If this heat pump is installed with a **ComfortBridge** compatible furnace, the system is recognized as a dual fuel system. The balance point temperature should be set via the indoor unit. See indoor unit instruction manual for details on how to set the balance point.

SYSTEM TROUBLESHOOTING

NOTE: REFER TO THE INSTRUCTIONS ACCOMPANYING THE CT COMPATIBLE INDOOR AIR HANDLER/FURNACE/MODULAR BLOWER UNIT FOR TROUBLESHOOTING INFORMATION REGARDING INDOOR UNIT DIAGNOSTICS.

Refer to the Troubleshooting Chart at the end of this manual for a listing of possible air conditioner and heat pump error codes, possible causes and corrective actions.

TROUBLESHOOTING INFORMATION: CONDENSING UNIT

| Complaint | No Cooling | | | | | | | Unsatisfactory Cooling/Heating | | | | | | | System Operating Pressures | | | | Test Method Remedy |
|---------------------------------------|-----------------------|--------------------------------------|------------------------------------|-------------------------------|------------------------------|--|-------------------------------|---|----------------------------|------------------------------|---|---------------------|---|---------------------------------|----------------------------|----------------------|-------------------|-----------------------|--|
| | System will not start | Compressor will not start - fan runs | Comp. and Cond. Fan will not start | Evaporator fan will not start | Condenser fan will not start | Compressor runs - goes off on overload | Compressor cycles on overload | System runs continuously - little cooling/htg | Too cool and then too warm | Not cool enough on warm days | Certain areas too cool, others too warm | Compressor is noisy | System runs - blows cold air in heating | Unit will not terminate defrost | Unit will not defrost | Low suction pressure | Low head pressure | High suction pressure | |
| Power Failure | • | | | | | | | | | | | | | | | | | | Test Voltage |
| Blown Fuse | • | | • | • | | | | | | | | | | | | | | | Inspect Fuse Size & Type |
| Unbalanced Power, 3PH | | • | | | | | | | | | | | | | | | | | Test Voltage |
| Loose Connection | • | | | • | | • | | | | | | | | | | | | | Inspect Connection - Tighten |
| Shorted or Broken Wires | • | • | • | • | • | • | | | | | | | | | | | | | Test Circuits With Ohmmeter |
| Open Fan Overload | | | | • | • | | | | | | | | | | | | | | Test Continuity of Overload |
| Faulty Thermostat | • | | • | • | | | | • | | | | | | | | | | | Test Continuity of Thermostat & Wiring |
| Faulty Transformer | • | | • | | | | | | | | | | | | | | | | Check Control Circuit with Voltmeter |
| Shorted or Open Capacitor | | • | | • | • | • | • | | | | | | | | | | | | Test Capacitor |
| Internal Compressor Overload Open | | • | | | | | | | | | | ♦ | | | | | | | Test Continuity of Overload |
| Shorted or Grounded Compressor | | • | | | | • | | | | | | | ♦ | | | | | | Test Motor Windings |
| Compressor Stuck | | • | | | | • | • | | | | | | ♦ | | | | | | Use Test Cord |
| Faulty Compressor Contactor | | | • | | • | • | | | | | | | | | | | | | Test Continuity of Coil & Contacts |
| Faulty Fan Relay | | | | • | | | | | | | | | | | | | | | Test Continuity of Coil And Contacts |
| Open Control Circuit | | | | • | | | | | | | | | | | | | | | Test Control Circuit with Voltmeter |
| Low Voltage | | • | | | | • | • | | | | | | | | | | | | Test Voltage |
| Faulty Evap. Fan Motor | | | | • | | | | | | | | | | | • | | ♦ | | Repair or Replace |
| Shorted or Grounded Fan Motor | | | | | • | | | | | | | | | | | | | • | Test Motor Windings |
| Improper Cooling Anticipator | | | | | | | • | | | | | | | | | | | | Check Resistance of Anticipator |
| Shortage of Refrigerant | | | | | | | • | • | | | | | ♦ | | • | • | | | Test For Leaks, Add Refrigerant |
| Restricted Liquid Line | | | | | | | • | • | | | | | | | • | • | | • | Remove Restriction, Replace Restricted Part |
| Open Element or Limit on Elec. Heater | | | | | | | | ♦ | | | | ♦ | | | | | | | Test Heater Element and Controls |
| Dirty Air Filter | | | | | | | | • | • | • | | | | | • | | | ♦ | Inspect Filter-Clean or Replace |
| Dirty Indoor Coil | | | | | | | | • | • | • | | | | | • | | | ♦ | Inspect Coil - Clean |
| Not enough air across Indoor Coil | | | | | | | | • | • | • | | | | | • | | | ♦ | Check Blower Speed, Duct Static Press, Filter |
| Too much air across Indoor Coil | | | | | | | | | | | | | | | ♦ | • | | | Reduce Blower Speed |
| Overcharge of Refrigerant | | | | | • | • | | | | | • | ♦ | | | | | • | | Recover Part of Charge |
| Dirty Outdoor Coil | | | | | • | • | | | • | | | | | | ♦ | | | • | Inspect Coil - Clean |
| Noncondensibles | | | | | | | • | | • | | | ♦ | | | | | | • | Recover Charge, Evacuate, Recharge |
| Recirculation of Condensing Air | | | | | | | • | | • | | | | | | | | | • | Remove Obstruction to Air Flow |
| Infiltration of Outdoor Air | | | | | | | • | • | • | | | | | | | | | | Check Windows, Doors, Vent Fans, Etc. |
| Improperly Located Thermostat | | | | | • | | | • | | | | | | | | | | | Relocate Thermostat |
| Air Flow Unbalanced | | | | | | | | • | • | | | | | | | | | | Readjust Air Volume Dampers |
| System Undersized | | | | | | | • | • | | | | | | | | | | | Refigure Cooling Load |
| Broken Internal Parts | | | | | | | | | | | • | ♦ | | | | | | | Replace Compressor |
| Broken Valves | | | | | | | • | | | | • | | | | • | • | | | Test Compressor Efficiency |
| Inefficient Compressor | | | | | | | • | | | | | ♦ | | | • | • | | | Test Compressor Efficiency |
| Wrong Type Expansion Valve | | | | | • | • | • | • | | | | | | | • | • | ♦ | | Replace Valve |
| Expansion Device Restricted | | | | | • | • | • | • | | | | | | | • | • | | • | Remove Restriction or Replace Expansion Device |
| Oversized Expansion Valve | | | | | | | • | | | | | | | | | | | • | Replace Valve |
| Undersized Expansion Valve | | | | | • | • | • | • | | | | | | | • | | | | Replace Valve |
| Expansion Valve Bulb Loose | | | | | | | | | | | • | | | | | | | • | Tighten Bulb Bracket |
| Inoperative Expansion Valve | | | | | • | | • | | | | | | | | • | | | | Check Valve Operation |
| Loose Hold-down Bolts | | | | | | | | | | • | | | | | | | | | Tighten Bolts |
| Faulty Reversing Valve | | | | | • | | | | | | | ♦ | ♦ | ♦ | | | ♦ | ♦ | Replace Valve or Solenoid |
| Faulty Defrost Control | | | | | • | | | | | | | ♦ | ♦ | ♦ | ♦ | ♦ | | ♦ | Test Control |
| Faulty Defrost Thermostat | | | | | | | | | | | | ♦ | ♦ | ♦ | ♦ | ♦ | | ♦ | Test Defrost Thermostat |
| Flowrator Not Seating Properly | | | | | | | • | | | | | | | | • | • | | | Check Flowrator & Seat or Replace Flowrator |

• Cooling or Heating Cycle (Heat Pump)

♦ Heating Cycle Only (Heat Pump)

For detailed service information refer to the Remote Condensing Unit Service manual.

TROUBLESHOOTING INFORMATION: UNITARY DIAGNOSTIC CODES

| SYSTEM TROUBLESHOOTING | | | | | | | |
|---|-------------------------------------|--------|---------|---|--|---|--|
| UNITARY DIAGNOSTIC CODES | | | | | | | |
| Symptoms of Abnormal Operation | Diagnostic/Status LED Display Codes | | | Fault Description | Possible Causes | Corrective Actions | Notes & Cautions |
| | Digit3 | Digit2 | Digit 1 | | | | |
| <ul style="list-style-type: none"> • Integrated control module diagnostic/status LED display shows the indicated code. | BLANK | A | 2 | <ul style="list-style-type: none"> • Outdoor air temp sensor fault | <ul style="list-style-type: none"> • Shorted sensor. • Open sensor. • Sensor disconnected. • Sensor out of range. | <ul style="list-style-type: none"> • Check sensor connection. • Replace open/shorted sensor. | <ul style="list-style-type: none"> • Turn power OFF prior to repair. • Replace with correct replacement part. |
| <ul style="list-style-type: none"> • Heat pump fails to operate in heating mode. • Integrated control module diagnostic/status LED display shows the indicated code. | BLANK | A | 3 | <ul style="list-style-type: none"> • Outdoor coil temp sensor fault | <ul style="list-style-type: none"> • Shorted sensor • Open sensor. • Sensor. disconnected. • Sensor out of range. | <ul style="list-style-type: none"> • Check sensor connection. • Replace open/shorted sensor. | <ul style="list-style-type: none"> • Turn power OFF prior to repair. • Replace with correct replacement part. |
| <ul style="list-style-type: none"> • Air conditioner/heat pump fails to operate. • Integrated control module diagnostic/status LED display shows the indicated code. | BLANK | E | 5 | <ul style="list-style-type: none"> • Open fuse | <ul style="list-style-type: none"> • Short in low voltage wiring. | <ul style="list-style-type: none"> • Locate and correct short in low voltage wiring. | <ul style="list-style-type: none"> • Turn power OFF prior to repair. • Replace fuse with 3-amp automotive type. |
| <ul style="list-style-type: none"> • Air conditioner/heat pump fails to operate. • Integrated control module diagnostic/status LED display shows the indicated code. | BLANK | E | E | <ul style="list-style-type: none"> • Board mis- operation | <ul style="list-style-type: none"> • Compressor relay contacts welded. | <ul style="list-style-type: none"> • Replace control. | <ul style="list-style-type: none"> • Turn power OFF prior to repair • Replace with correct replacement part. |
| <ul style="list-style-type: none"> • Air conditioner/heat pump fails to operate. • Integrated control module diagnostic/status LED display shows the indicated code. | BLANK | b | 0 | <ul style="list-style-type: none"> • Circulator blower motor is not running when it should be running. | <ul style="list-style-type: none"> • Indoor blower motor problem. • Communications error between indoor and outdoor unit. | <ul style="list-style-type: none"> • Check indoor blower motor. • Check indoor blower motor wiring. • Check indoor unit control. • Repair/ replace any faulty wiring. • Repair/replace indoor blower motor or control. | <ul style="list-style-type: none"> • Turn power OFF prior to repair. • Replace with correct replacement part. |
| <ul style="list-style-type: none"> • Air conditioner/heat pump operates at reduced performance. • Air conditioner/heat pump operating at low stage when expected to operate at high stage. • Integrated control module diagnostic/status LED display shows the indicated code. | BLANK | b | 9 | <ul style="list-style-type: none"> • Air flow is lower than demanded | <ul style="list-style-type: none"> • Indoor blower motor problem • Blocked filters . • Restrictive/ undersized ductwork • Indoor/ outdoor unit miss-match. | <ul style="list-style-type: none"> • Check indoor blower motor. • Check Filters clean/replace as needed. • Check ductwork, resize as needed. • Verify indoor and outdoor units are properly matched. | <ul style="list-style-type: none"> • Turn power OFF prior to repair. • Replace with correct replacement part. See specification sheets for airflow requirements and maximum external static pressure. • See specification sheets for approved system matches. |

TROUBLESHOOTING INFORMATION: UNITARY DIAGNOSTIC CODES

| UNITARY DIAGNOSTIC CODES | | | | | | | |
|---|-------------------------------------|--------|---------|---|--|--|---|
| Symptoms of Abnormal Operation | Diagnostic/Status LED Display Codes | | | Fault Description | Possible Causes | Corrective Actions | Notes & Cautions |
| | Digit3 | Digit2 | Digit 1 | | | | |
| <ul style="list-style-type: none"> • Air conditioner/heat pump fails to operate. • Integrated control module diagnostic/status LED display shows the indicated code. | BLANK | d | 0 | <ul style="list-style-type: none"> • Data not yet on Network | <ul style="list-style-type: none"> • Air conditioner/ heat pump is wired as part of a communicating system and integrated control module does not contain any shared data. | <ul style="list-style-type: none"> • Verify system type (communicating or legacy) • Populate shared data using memory card • Wire system as legacy system | <ul style="list-style-type: none"> • Turn power OFF prior to repair. • Use memory card for your specific model. • Insert memory card BEFORE turning power ON. Memory card may be removed after data is loaded. • Turn power OFF before removing memory card. • Error code will be cleared once data is loaded. |
| <ul style="list-style-type: none"> • Air conditioner/heat pump fails to operate. • Integrated control module diagnostic/status LED display shows the indicated code. | BLANK | d | 1 | <ul style="list-style-type: none"> • Invalid Data on Network | <ul style="list-style-type: none"> • Air conditioner/ heat pump is wired as part of a communicating system and integrated control module contains invalid shared data or network data is invalid for the integrated control module. | <ul style="list-style-type: none"> • Verify system type (communicating or legacy). • Populate correct shared data using memory card. • Wire system as legacy system. | <ul style="list-style-type: none"> • Turn power OFF prior to repair. • Use memory card for your specific model. • Insert memory card BEFORE turning power ON. Memory card may be removed after data is loaded. • Turn power OFF before removing memory card. • Error code will be cleared once data is loaded. |
| <ul style="list-style-type: none"> • Air conditioner/heat pump fails to operate. • Air conditioner/heat pump operating at reduced performance. • Air conditioner/heat pump operating at low stage when e peeled to operate at high stage. • Integrated control module diagnostic/status LED display shows the indicated code. | BLANK | d | 2 | <ul style="list-style-type: none"> • System Mis-Match | <ul style="list-style-type: none"> • Air conditioner/ heat pump is wired as part of a communicating system and outdoor unit requires air flow greater than indoor units airflow capability. • Shared data is incompatible with the system or missing parameters. | <ul style="list-style-type: none"> • Verify system type (communicating or legacy). • Verify shared data is correct for your specific model repopulate data if required. • Wire system as legacy system. | <ul style="list-style-type: none"> • Turn power OFF prior to repair. • Use memory card for your specific model. • Insert memory card BEFORE turning power ON. Memory card may be removed after data is loaded. • Turn power OFF before removing memory card. • Error code will be cleared once data is loaded. |

TROUBLESHOOTING INFORMATION: UNITARY DIAGNOSTIC CODES

| UNITARY DIAGNOSTIC CODES | | | | | | | |
|--|-------------------------------------|---------|---------|---|--|---|--|
| Symptoms of Abnormal Operation | Diagnostic/Status LED Display Codes | | | Fault Description | Possible Causes | Corrective Actions | Notes & Cautions |
| | Digit 3 | Digit 2 | Digit 1 | | | | |
| <ul style="list-style-type: none"> • Air conditioner/heat pump fails to operate. • Integrated control module diagnostic/status LED display shows the indicated code. | BLANK | d | 3 | <ul style="list-style-type: none"> • Configuration Mismatch | <ul style="list-style-type: none"> • Shared data sent to integrated control module does not match hardware configuration. | <ul style="list-style-type: none"> • Verify system type (communicating or legacy). • Verify shared data is correct for your specific model; re-populate data if required. • Wire system as legacy system. | <ul style="list-style-type: none"> • Turn power OFF prior to repair. • Use memory card for your specific model. • Insert memory card BEFORE turning power ON. Memory card may be removed after data is loaded. Turn power OFF before removing memory card. • Error code will be cleared once data is loaded. |
| <ul style="list-style-type: none"> • Air conditioner/heat pump fails to operate. • Integrated control module diagnostic/status LED display shows the indicated code. | BLANK | d | 4 | <ul style="list-style-type: none"> • Invalid Memory Card Data | <ul style="list-style-type: none"> • Shared data on memory card has been rejected. | <ul style="list-style-type: none"> • Verify system type (communicating or legacy). • Verify shared data is correct for your specific model; re-populate data if required. • Wire system as legacy system. | <ul style="list-style-type: none"> • Turn power OFF prior to repair. • Use memory card for your specific model. • Insert memory card BEFORE turning power ON. Memory card may be removed after data is loaded. Turn power OFF before removing memory card. • Error code will be cleared once data is loaded. |
| <ul style="list-style-type: none"> • Very long run time. • Four consecutive compressor protector trips with average run time between trips greater than 3 hours. • Compressor operating at high speed and outdoor fan operating at low speed • Integrated control module diagnostic/status LED display shows the indicated code. | BLANK | 0 | 1 | <ul style="list-style-type: none"> • Low Side Fault | <ul style="list-style-type: none"> • Low refrigerant charge. • Restriction in liquid line. • Indoor blower motor failure. • Indoor thermostat set extremely low. | <ul style="list-style-type: none"> • Verify refrigerant charge; adjust as needed. • Check for restricted liquid line; repair/replace as needed. • Check indoor blower motor; repair/replace as needed. • Check indoor thermostat setting. | <ul style="list-style-type: none"> • Turn power OFF prior to repair. • Fault will clear after 3 consecutive normal cycles. • Fault may be cleared by cycling 4V AC to control. • Replace with correct replacement part(s). |
| <ul style="list-style-type: none"> • Compressor and outdoor fan are off. • Thermostat demand is present. • Integrated control module diagnostic/status LED display shows the indicated code. | BLANK | 0 | 1 | <ul style="list-style-type: none"> • Low Pressure Cut Out Trip | <ul style="list-style-type: none"> • Low refrigerant charge. • Restriction in liquid line. • Indoor blower motor failure. • Indoor thermostat set extremely low. | <ul style="list-style-type: none"> • Verify refrigerant charge; adjust as needed. • Check for restricted liquid line; repair/replace as needed. • Check indoor blower motor; repair/replace as needed. • Check low pressure switch; repair/replace as needed. • Check indoor thermostat setting. | <ul style="list-style-type: none"> • Turn power OFF prior to repair. • Replace with correct replacement part(s). |

TROUBLESHOOTING INFORMATION: UNITARY DIAGNOSTIC CODES

| UNITARY DIAGNOSTIC CODES | | | | | | | |
|--|-------------------------------------|--------|---------|---|--|---|--|
| Symptoms of Abnormal Operation | Diagnostic/Status LED Display Codes | | | Fault Description | Possible Causes | Corrective Actions | Notes & Cautions |
| | Digit3 | Digit2 | Digit 1 | | | | |
| <ul style="list-style-type: none"> • Compressor and outdoor fan are off. • Low pressure switch trip 3 times within same thermostat demand. • Thermostat demand is present. • Intergrated control module diagnostic/status LED display shows the indicated code. | BLANK | L | 1 | <ul style="list-style-type: none"> • Low Pressure Cut Out Lockout (3 Trips) | <ul style="list-style-type: none"> • Low refrigerant charge. • Restriction in liquid line. • Indoor blower motor failure. • Indoor thermostat set extremely low. | <ul style="list-style-type: none"> • Verify refrigerant charge; adjust as needed. • Check for restricted liquid line; repair/replace as needed. • Check indoor blower motor; repair/replace as needed. • Check low pressure switch; repair/replace as needed. • Check indoor thermostat setting. | <ul style="list-style-type: none"> • Turn power OFF prior to repair. • Must clear fault by cycling 24 VAC to control. • Replace with correct replacement part(s). |
| <ul style="list-style-type: none"> • Four consecutive compressor protector trips with average run time between trips greater than 1 minute and less than 15 minutes. • Low pressure and high pressure switches are closed. • Intergrated control module diagnostic/status LED display shows the indicated code. | BLANK | 0 | 2 | <ul style="list-style-type: none"> • High Side Fault | <ul style="list-style-type: none"> • Blocked condenser coil. • Outdoor fan not running. | <ul style="list-style-type: none"> • Check and clean condenser coil. • Check outdoor fan motor; repair/replace as needed. • Check outdoor fan motor wiring; repair/replace as needed. • Check outdoor fan motor capacitor; replace as needed. | <ul style="list-style-type: none"> • Turn power OFF prior to repair. • Fault will clear after 4 consecutive normal cycles. • Fault may be cleared by cycling 24 VAC to control. • Replace with correct replacement part(s) |
| <ul style="list-style-type: none"> • Compressor and outdoor fan are off. • Thermostat demand is present. • Intergrated control module diagnostic/status LED display shows the indicated code. | BLANK | 0 | 2 | <ul style="list-style-type: none"> • High Pressure Cut Out Trip | <ul style="list-style-type: none"> • Blocked condenser coil. • Outdoor fan not running. | <ul style="list-style-type: none"> • Check and clean condenser coil. • Check outdoor fan motor; repair/replace as needed. • Check outdoor fan motor wiring; repair/replace as needed. • Check outdoor fan motor capacitor; replace as needed. | <ul style="list-style-type: none"> • Turn power OFF prior to repair. • Replace with correct replacement part(s). |
| <ul style="list-style-type: none"> • Compressor and outdoor fan are off. • Low pressure switch trip 3 times within same thermostat demand. • Thermostat demand is present. • Intergrated control module diagnostic/status LED display shows the indicated code. | BLANK | L | 2 | <ul style="list-style-type: none"> • High Pressure Cut Out Lockout (3 Trips) | <ul style="list-style-type: none"> • Blocked condenser coil. • Outdoor fan not running. | <ul style="list-style-type: none"> • Check and clean condenser coil. • Check outdoor fan motor; repair/replace as needed. • Check outdoor fan motor wiring; repair/replace as needed. • Check outdoor fan motor capacitor; replace as needed. | <ul style="list-style-type: none"> • Turn power OFF prior to repair. • Must clear fault by cycling 24 VAC to control. • Replace with correct replacement part(s). |

TROUBLESHOOTING INFORMATION: UNITARY DIAGNOSTIC CODES

| UNITARY DIAGNOSTIC CODES | | | | | | | |
|--|-------------------------------------|--------|---------|--|---|--|--|
| Symptoms of Abnormal Operation | Diagnostic/Status LED Display Codes | | | Fault Description | Possible Causes | Corrective Actions | Notes & Cautions |
| | Digit3 | Digit2 | Digit 1 | | | | |
| <ul style="list-style-type: none"> • Run time for last 4 cycles is less than 3 minutes each. • Compressor protector has not tripped. • Low pressure and high pressure switches are closed. • Integrated control module diagnostic/status LED display shows the indicated code. | BLANK | 0 | 3 | <ul style="list-style-type: none"> • Short Cycling | <ul style="list-style-type: none"> • Intermittent thermostat demand. • Faulty compressor relay. | <ul style="list-style-type: none"> • Check thermostat and thermostat wiring; repair/replace as needed. • Check compressor relay operation; replace control as needed. | <ul style="list-style-type: none"> • Turn power OFF prior to repair. • Fault will clear after 4 consecutive normal cycles. • Fault may be cleared by cycling 24VAC to control. • Replace with correct replacement part(s). • Minimum compressor run time is changed from 30 seconds to 3 minutes. |
| <ul style="list-style-type: none"> • Compressor and outdoor fan are off. • Compressor protector trips four consecutive times. • Average run time between trips is less than 15 seconds. • Integrated control module diagnostic/status LED display shows the indicated code. | BLANK | 0 | 4 | <ul style="list-style-type: none"> • Locked Rotor | <ul style="list-style-type: none"> • Compressor bearings are seized. • Failed compressor run capacitor. • Faulty run capacitor wiring. • Low line voltage. | <ul style="list-style-type: none"> • Check compressor operation; repair/replace as needed. • Check run capacitor; replace as needed. • Check wiring; repair/replace as needed. • Verify line voltage is within range on rating plate; contact local utility is out of range. | <ul style="list-style-type: none"> • Turn power OFF prior to repair. • Must clear fault by cycling 24V AC to control. • Replace with correct replacement part(s). |
| <ul style="list-style-type: none"> • Compressor and outdoor fan are off for greater than 4 hours. • Low pressure and high pressure switches are closed. • Integrated control module diagnostic/status LED display shows the indicated code. | BLANK | 0 | 5 | <ul style="list-style-type: none"> • Open Circuit | <ul style="list-style-type: none"> • Power is disconnected. • Failed compressor protector. • Compressor not properly wired to control. | <ul style="list-style-type: none"> • Check circuit breakers and fuses. • Check wiring to unit; repair/replace as needed. • Check compressor repair/replace as needed. • Check compressor wiring; repair/replace as needed. | <ul style="list-style-type: none"> • Turn power OFF prior to repair. • Fault will clear after 1 normal cycle. • Fault may be cleared by cycling 24V AC to control. • Replace with correct replacement part(s). |
| <ul style="list-style-type: none"> • Compressor and outdoor fan are off. • Low pressure and high pressure switches are closed. • Integrated control module diagnostic/status LED display shows the indicated code. | BLANK | 0 | 6 | <ul style="list-style-type: none"> • Open Start Circuit | <ul style="list-style-type: none"> • Compressor start winding is open. • Failed compressor run capacitor. • Faulty run capacitor wiring. • Compressor not properly wired to control. • Faulty compressor wiring. | <ul style="list-style-type: none"> • Check compressor repair/replace as needed. • Check run capacitor; replace as needed. • Check wiring; repair/replace as needed. | <ul style="list-style-type: none"> • Turn power OFF prior to repair. • Fault will clear after 1 normal cycle. • Fault may be cleared by cycling 24V AC to control. • Replace will correct replacement part(s). |

TROUBLESHOOTING INFORMATION: UNITARY DIAGNOSTIC CODES

| UNITARY DIAGNOSTIC CODES | | | | | | | |
|---|-------------------------------------|---------|---------|---|--|---|--|
| Symptoms of Abnormal Operation | Diagnostic/Status LED Display Codes | | | Fault Description | Possible Causes | Corrective Actions | Notes & Cautions |
| | Digit 3 | Digit 2 | Digit 1 | | | | |
| <ul style="list-style-type: none"> • Air conditioner/heat pump may appear to be operating normally. • Compressor protector may be open (compressor and outdoor fan off). • Integrated control module diagnostic/status LED display shows the indicated code. | BLANK | H | 8 | <ul style="list-style-type: none"> • High Line Voltage | <ul style="list-style-type: none"> • High line voltage | <ul style="list-style-type: none"> • Correct high line voltage condition; contact local utility if needed. • Verify unit is connected to power supply as specified on rating plate. | <ul style="list-style-type: none"> • Turn power OFF prior to repair. • Control detects line voltage greater than 255 VAC. • Fault will clear if line voltage decreases below 255 VAC. |
| <ul style="list-style-type: none"> • Air conditioner/heat pump may appear to be operating normally. • Integrated control module diagnostic/status LED display shows the indicated code. | BLANK | 0 | 9 | <ul style="list-style-type: none"> • Low Pilot Voltage | <ul style="list-style-type: none"> • Control detects secondary voltage less than 18 VAC. • Transformer overloaded. • Low line voltage. | <ul style="list-style-type: none"> • Check fuse. • Correct low secondary voltage condition. • Check transformer; replace if needed. | <ul style="list-style-type: none"> • Turn power OFF prior to repair. • Fault will clear if secondary voltage rises above 21 VAC. • Replace with correct replacement part(s). |
| <ul style="list-style-type: none"> • Compressor is off. • Integrated control module diagnostic/status LED display shows the indicated code. | BLANK | P | 0 | <ul style="list-style-type: none"> • Comp protector Open | <ul style="list-style-type: none"> • No current through run or start windings. • Compressor run winding is open. • Compressor not properly wired to control. • Faulty Compressor wiring. • Failed compressor run capacitor. • Faulty run capacitor wiring. | <ul style="list-style-type: none"> • Check compressor; repair/replace as needed. • Check wiring repair/replaced as needed. • Check run capacitor; replace as needed. | <ul style="list-style-type: none"> • Turn power OFF prior to repair. • Fault will clear after 1 normal cycle. • Must clear fault by cycling 24 VAC to control. • Replace with correct replacement part(s). |
| <ul style="list-style-type: none"> • Air conditioner/heat pump may appear to be operating normally. • Compressor protector may be open (compressor and outdoor fan off). • Integrated control module diagnostic/status LED display shows the indicated code. | BLANK | L | 8 | <ul style="list-style-type: none"> • Low Line Voltage | <ul style="list-style-type: none"> • Low line voltage. | <ul style="list-style-type: none"> • Check circuit breakers and fuses. • Verify unit is connected to power supply as specified on rating plate. • Correct low line voltage condition; contact local utility if needed. | <ul style="list-style-type: none"> • Turn power OFF prior to repair. • Control detects line voltage less than 185 VAC. • Fault will clear if line voltage increases above 185 VAC. |
| <ul style="list-style-type: none"> • Air conditioner/heat pump may appear to be operating normally. • Compressor protector may be open (compressor and outdoor fan off). • Integrated control module diagnostic/status LED display shows the indicated code. | BLANK | L | 8 | <ul style="list-style-type: none"> • No Line Voltage | <ul style="list-style-type: none"> • No line voltage. | <ul style="list-style-type: none"> • Check circuit breakers and fuses. • Verify unit is connected to power supply as specified on rating plate. | <ul style="list-style-type: none"> • Turn power OFF prior to repair. • Control detects line voltage less than 185 VAC. • Fault will clear if line voltage increases above 185 VAC. |

TROUBLESHOOTING INFORMATION: UNITARY DIAGNOSTIC CODES

| UNITARY DIAGNOSTIC CODES | | | | | | | |
|---|-------------------------------------|---------|---------|---|--|---|--|
| Symptoms of Abnormal Operation | Diagnostic/Status LED Display Codes | | | Fault Description | Possible Causes | Corrective Actions | Notes & Cautions |
| | Digit 3 | Digit 2 | Digit 1 | | | | |
| <ul style="list-style-type: none"> • Air conditioner/heat pump may appear to be operating normally. • Compressor protector may be open (compressor and outdoor fan off). • Integrated control module diagnostic/status LED display shows the indicated code. | BLANK | H | 8 | <ul style="list-style-type: none"> • High Line Voltage | <ul style="list-style-type: none"> • High line voltage | <ul style="list-style-type: none"> • Correct high line voltage condition; contact local utility if needed. • Verify unit is connected to power supply as specified on rating plate. | <ul style="list-style-type: none"> • Turn power OFF prior to repair. • Control detects line voltage greater than 255 VAC. • Fault will clear if line voltage decreases below 255 VAC. |
| <ul style="list-style-type: none"> • Air conditioner/heat pump may appear to be operating normally. • Integrated control module diagnostic/status LED display shows the indicated code. | BLANK | 0 | 9 | <ul style="list-style-type: none"> • Low Pilot Voltage | <ul style="list-style-type: none"> • Control detects secondary voltage less than 18 VAC. • Transformer overloaded. • Low line voltage. | <ul style="list-style-type: none"> • Check fuse. • Correct low secondary voltage condition. • Check transformer; replace if needed. | <ul style="list-style-type: none"> • Turn power OFF prior to repair. • Fault will clear if secondary voltage rises above 21VAC. • Replace with correct replacement part(s). |
| <ul style="list-style-type: none"> • Compressor is off. • Integrated control module diagnostic/status LED display shows the indicated code. | BLANK | P | 0 | <ul style="list-style-type: none"> • Comp protector Open | <ul style="list-style-type: none"> • No current through run or start windings. • Compressor run winding is open. • Compressor not properly wired to control. • Faulty Compressor wiring. • Failed compressor run capacitor. • Faulty run capacitor wiring. | <ul style="list-style-type: none"> • Check compressor; repair/replace as needed. • Check wiring repair/replaced as needed. • Check run capacitor; replace as needed. | <ul style="list-style-type: none"> • Turn power OFF prior to repair. • Fault will clear after 1 normal cycle. • Must clear fault by cycling 24 VAC to control. • Replace with correct replacement part(s). |
| <ul style="list-style-type: none"> • Air conditioner/heat pump may appear to be operating normally. • Compressor protector may be open (compressor and outdoor fan off). • Integrated control module diagnostic/status LED display shows the indicated code. | BLANK | L | 8 | <ul style="list-style-type: none"> • Low Line Voltage | <ul style="list-style-type: none"> • Low line voltage. | <ul style="list-style-type: none"> • Check circuit breakers and fuses. • Verify unit is connected to power supply as specified on rating plate. • Correct low line voltage condition; contact local utility if needed. | <ul style="list-style-type: none"> • Turn power OFF prior to repair. • Control detects line voltage less than 185 VAC. • Fault will clear if line voltage increases above 185 VAC. |
| <ul style="list-style-type: none"> • Air conditioner/heat pump may appear to be operating normally. • Compressor protector may be open (compressor and outdoor fan off). • Integrated control module diagnostic/status LED display shows the indicated code. | BLANK | L | 8 | <ul style="list-style-type: none"> • No Line Voltage | <ul style="list-style-type: none"> • No line voltage. | <ul style="list-style-type: none"> • Check circuit breakers and fuses. • Verify unit is connected to power supply as specified on rating plate. | <ul style="list-style-type: none"> • Turn power OFF prior to repair. • Control detects line voltage less than 185 VAC. • Fault will clear if line voltage increases above 185 VAC. |

SPLIT SYSTEMS

AIR CONDITIONING AND HEAT PUMP HOMEOWNER'S ROUTINE MAINTENANCE RECOMMENDATIONS

We strongly recommend a bi-annual maintenance checkup be performed before the heating and cooling seasons begin by a qualified servicer.

REPLACE OR CLEAN FILTER

IMPORTANT NOTE: Never operate unit without a filter installed as dust and lint will build up on internal parts resulting in loss of efficiency, equipment damage and possible fire.

An indoor air filter must be used with your comfort system. A properly maintained filter will keep the indoor coil of your comfort system clean. A dirty coil could cause poor operation and/or severe equipment damage.

Your air filter or filters could be located in your furnace, in a blower unit, or in "filter grilles" in your ceiling or walls. The installer of your air conditioner or heat pump can tell you where your filter(s) are, and how to clean or replace them. Check your filter(s) at least once a month. When they are dirty, replace or clean as required. Disposable type filters should be replaced. Reusable type filters may be cleaned.

You may want to ask your dealer about high efficiency filters. High efficiency filters are available in both electronic and non-electronic types. These filters can do a better job of catching small airborne particles.

COMPRESSOR

The compressor motor is hermetically sealed and does not require additional oiling.

MOTORS

Indoor and outdoor fan motors are permanently lubricated and do not require additional oiling.

CLEAN OUTSIDE COIL (QUALIFIED SERVICER ONLY)



WARNING

HIGH VOLTAGE

DISCONNECT ALL POWER BEFORE SERVICING OR INSTALLING THIS UNIT. MULTIPLE POWER SOURCES MAY BE PRESENT. FAILURE TO DO SO MAY CAUSE PROPERTY DAMAGE, PERSONAL INJURY OR DEATH.



Air must be able to flow through the outdoor unit of your comfort system. Do not construct a fence near the unit or build a deck or patio over the unit without first discussing your plans with your dealer or other qualified servicer. Restricted airflow could lead to poor operation and/or severe equipment damage.

Likewise, it is important to keep the outdoor coil clean. Dirt, leaves, or debris could also restrict the airflow. If cleaning of the outdoor coil becomes necessary, hire a qualified servicer. Inexperienced people could easily puncture the tubing in the coil. Even a small hole in the tubing could eventually cause a large loss of refrigerant. Loss of refrigerant can cause poor operation and/or severe equipment damage.

Do not use a condensing unit cover to "protect" the outdoor unit during the winter, unless you first discuss it with your dealer. Any cover used must include "breathable" fabric to avoid moisture buildup.

BEFORE CALLING YOUR SERVICER

- Check the thermostat to confirm that it is properly set.
- Wait 15 minutes. Some devices in the outdoor unit or in programmable thermostats will prevent compressor operation for awhile, and then reset automatically. Also, some power companies will install devices which shut off air conditioners for several minutes on hot days. If you wait several minutes, the unit may begin operation on its own.
- Check the electrical panel for tripped circuit breakers or failed fuses. Reset the circuit breakers or replace fuses as necessary.
- Check the disconnect switch near the indoor furnace or blower to confirm that it is closed.
- Check for obstructions on the outdoor unit. Confirm that it has not been covered on the sides or the top. Remove any obstruction that can be safely removed. If the unit is covered with dirt or debris, call a qualified servicer to clean it.
- Check for blockage of the indoor air inlets and outlets. Confirm that they are open and have not been blocked by objects (rugs, curtains or furniture).
- Check the filter. If it is dirty, clean or replace it.
- Listen for any unusual noise(s), other than normal operating noise, that might be coming from the outdoor unit. If you hear unusual noise(s) coming from the unit, call a qualified servicer.



CAUTION

TO AVOID THE RISK OF EQUIPMENT DAMAGE OR FIRE, INSTALL THE SAME AMPERAGE BREAKER OR FUSE AS YOU ARE REPLACING. IF THE CIRCUIT BREAKER OR FUSE SHOULD OPEN AGAIN WITHIN THIRTY DAYS, CONTACT A QUALIFIED SERVICER TO CORRECT THE PROBLEM. IF YOU HAVE REPEATEDLY RESET THE BREAKER OR REPLACED THE FUSE WITHOUT HAVING THE PROBLEM CORRECTED, YOU RUN THE RISK OF SEVERE EQUIPMENT DAMAGE.

START-UP CHECKLIST

| Condenser / Heat Pump (including all Inverter) | | | |
|--|----------------------|-------------|-------------|
| | Model Number | _____ | |
| | Serial Number | _____ | |
| ELECTRICAL (Outdoor Unit) | | | |
| Line Voltage (Measure L1 and L2 Voltage) | L1 - L2 | _____ | |
| Secondary Voltage (Measure Transformer Output Voltage) NOT ALL MODELS | R - C | _____ | |
| Compressor Amps | | _____ | |
| Condenser Fan Amps | | _____ | |
| TEMPERATURES (Indoor Unit) | | | |
| Return Air Temperature (Dry bulb / Wet bulb) | | DB °F _____ | WB °F _____ |
| Cooling Supply Air Temperature (Dry bulb / Wet bulb) | | DB °F _____ | WB °F _____ |
| Delta T (Difference between Supply and Return Temperatures) | | DB °F _____ | |
| PRESSURES / TEMPERATURES (Outdoor Unit) | | | |
| Suction Circuit (Pressure / Suction Line Temperature) | PSIG _____ | TEMP _____ | °F _____ |
| Liquid Circuit (Pressure / Liquid Temperature) | PSIG _____ | TEMP _____ | °F _____ |
| Outdoor Air Temperature (Dry bulb / Wet bulb) | | DB °F _____ | WB °F _____ |
| SUPERHEAT / SUBCOOLING | | | |
| Line set length in Feet | SH _____ | SC _____ | |
| Additional Refrigerant Charge Added over Factory Charge (Ounces) | | _____ | |
| | | _____ | |
| Additional Checks | | | |
| Check wire routings for any rubbing | | _____ | |
| Check factory wiring and wire connections. | | _____ | |
| Check product for proper clearances as noted by installation instructions | | _____ | |
| | | _____ | |
| °F to °C formula: (°F - 32) divided by 1.8 = °C °C to °F formula: (°C multiplied by 1.8) + 32 = °F | | | |

THIS PAGE LEFT INTENTIONALLY BLANK

CUSTOMER FEEDBACK

We are very interested in all product comments.
Please fill out the feedback form on one of the following links:
Goodman® Brand Products: (<http://www.goodmanmfg.com/about/contact-us>).
Amana® Brand Products: (<http://www.amana-hac.com/about-us/contact-us>).
You can also scan the QR code on the right for the product brand you purchased to be directed to the feedback page.



GOODMAN® BRAND



AMANA® BRAND

PRODUCT REGISTRATION

Thank you for your recent purchase. Though not required to get the protection of the standard warranty, registering your product is a relatively short process, and entitles you to additional warranty protection, except that failure by California and Quebec residents to register their product does not diminish their warranty rights. The duration of warranty coverages in Texas differs in some cases.

For Product Registration, please register as follows:
Goodman® Brand products: (<https://www.goodmanmfg.com/product-registration>).
Amana® Brand products: (<http://www.amana-hac.com/product-registration>).
You can also scan the QR code on the right for the product brand you purchased to be directed to the Product Registration page.



GOODMAN® BRAND



AMANA® BRAND

19001 Kermier Rd., Waller, TX 77484

www.goodmanmfg.com • www.amana-hac.com

© 2021-2023 Daikin Comfort Technologies Manufacturing, L.P.

Amana is a registered trademark of Maytag Corporation or its related companies and is used under license. All rights reserved.